

# Sea level rise – Northern European coasts



By

Ida Brøker, Morten Rugbjerg, Rolf Deigaard, Karsten Mangor  
DHI

EuDA

16 November 2011

# Overview of presentation



1. Types of coasts
2. Climate change – example of scenario
3. Consequences of climate change on coastal processes
4. Future design conditions
5. Key messages from CEDA WG on CCA: “Climate change adaptation as it affects the dredging community”
6. Examples of sustainable coastal developments/climate adaptation



# Climate change leads to:

Sea level rise:

- Coastal flooding
- Coastal erosion, progressive in nature

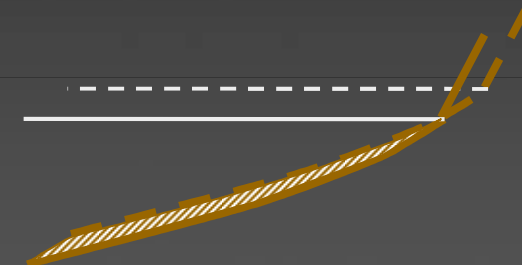
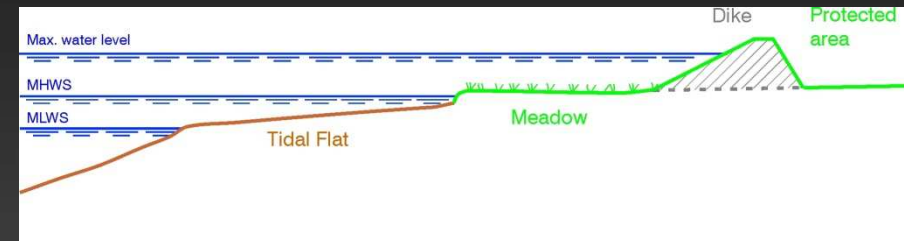

- Increased storm intensity, bigger waves and surges
- Changed directional characteristics of waves
- New distribution in precipitation =>
- Change in supply of sediments

Changes in coastal stability and flooding

Sea level rise:

From: <http://flood.firetree.net>

[Europe](#) [N. America](#) [S. A.](#)



Sea level rise:

From: <http://flood.firetree.net>

[Europe](#) [N. America](#) [S. Ar](#)



# Types of coasts

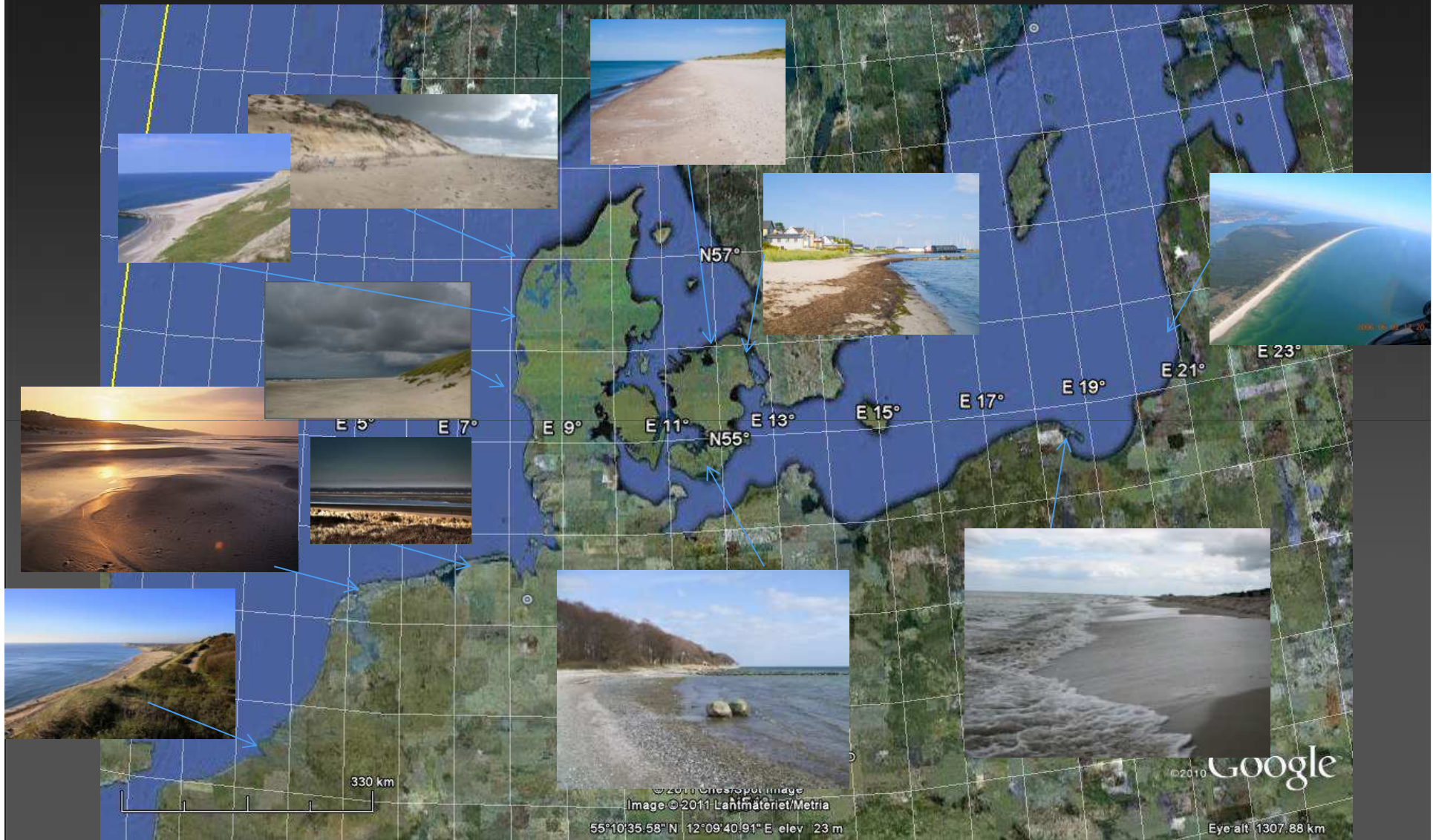

Long stretches of soft coastlines, varying from "protected" to "very exposed"  
Long stretches with lowlying hinterland – already protected by dikes/other structures

# Various estimates of global SLR in 2100:

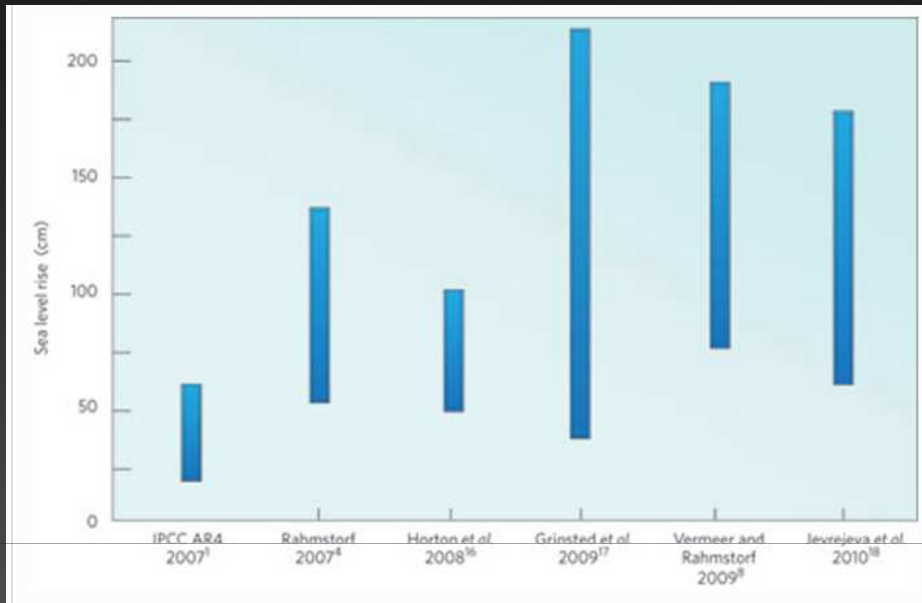

(from "A new view on sea level rise" by Stefan Rahmstorf)

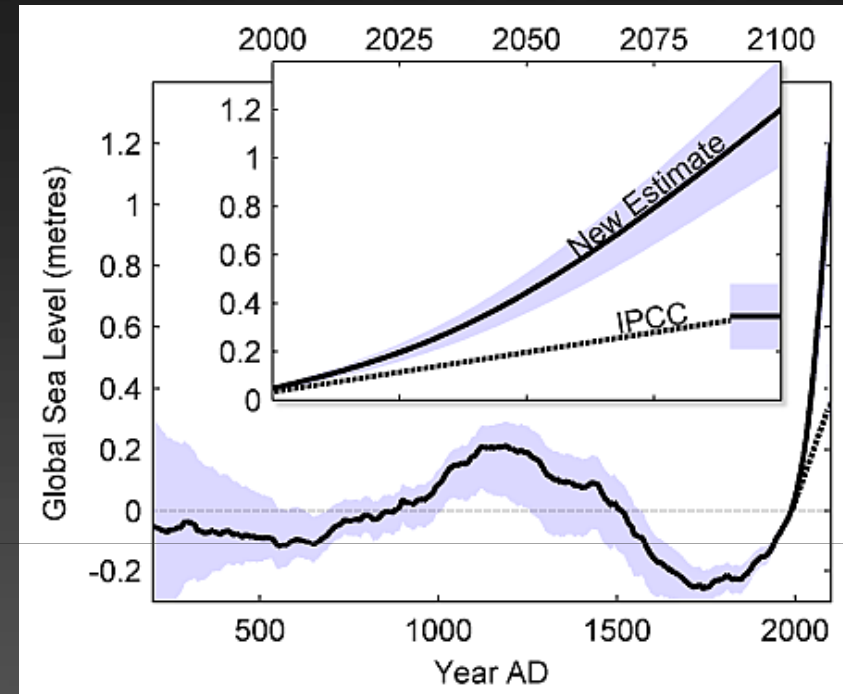

Reconstructing sea level from paleo and projected temperatures 200 to 2100 AD, A. Grinsted et al., 2009, *Clim. Dyn.*, DOI 10.1007/s00382-008-0707-2

# Consequences of climate change on coastal processes

Scenario: A1B from IPCC

Downscaling to coastal processes:

Global model : ARPEGE from Centre National de Recherches Météorologiques

Regional model: HIRHAM5 from Danish Meteorological Institute

SLR: Grindsted et al. (2009): 2090-2099

SLR, 5 - 95% percentiles: 0.91-1.32 m

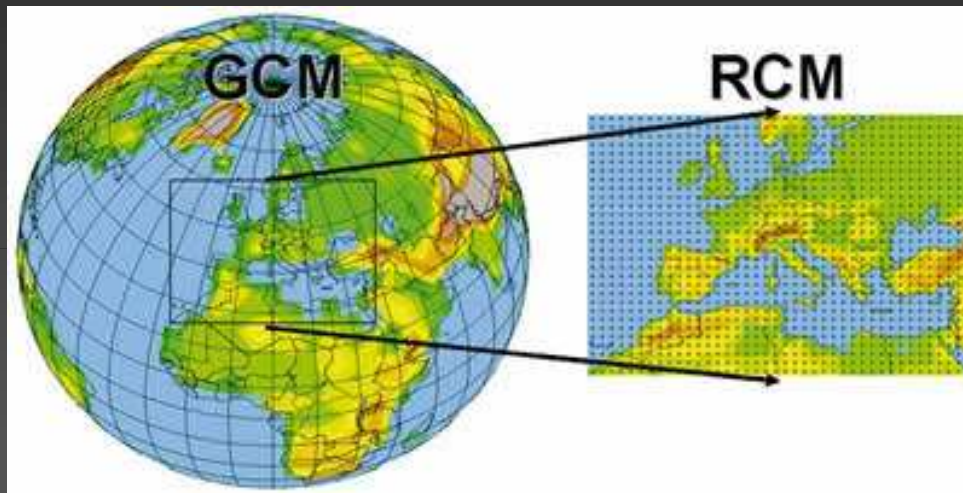

Wind and pressure fields

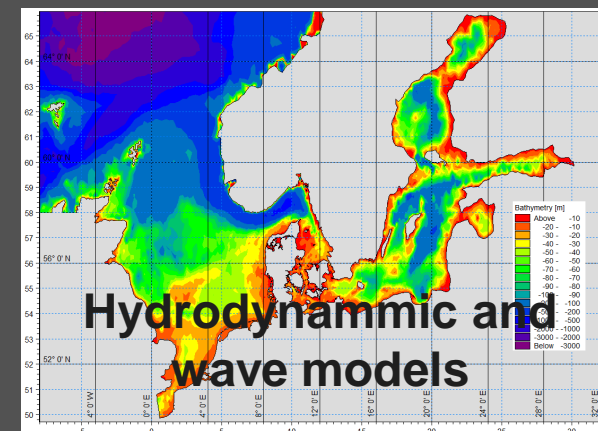

Water levels, currents and waves



Characteristic and extreme marine conditions



# Model domain

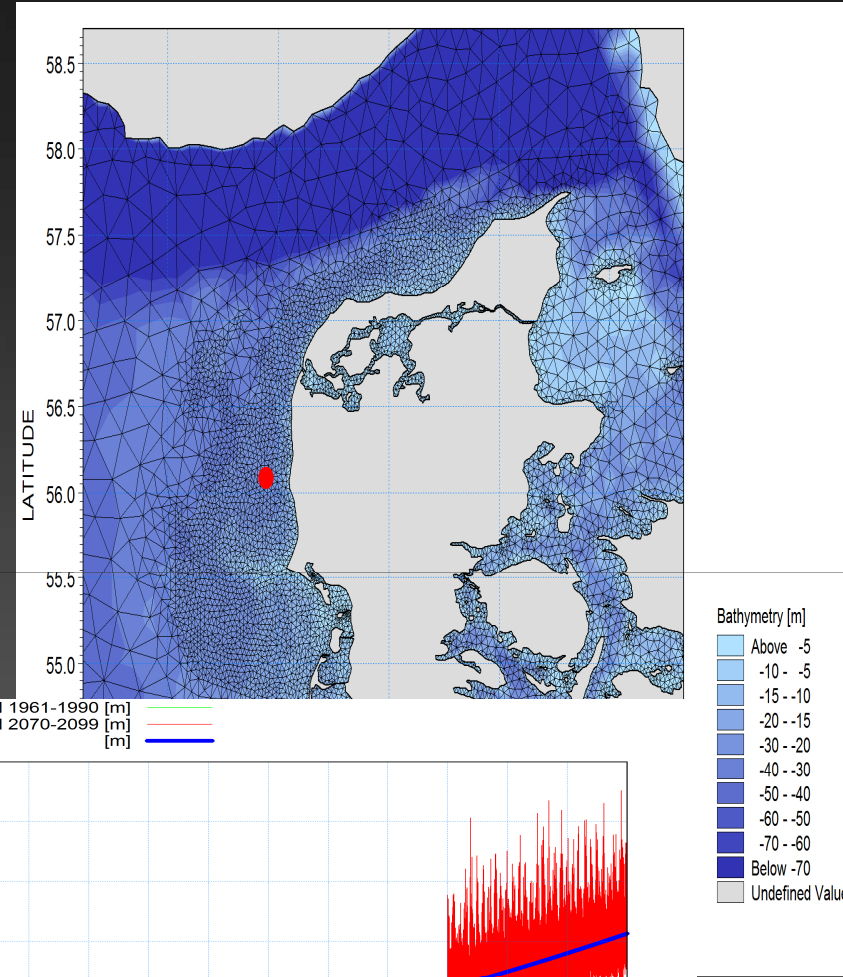
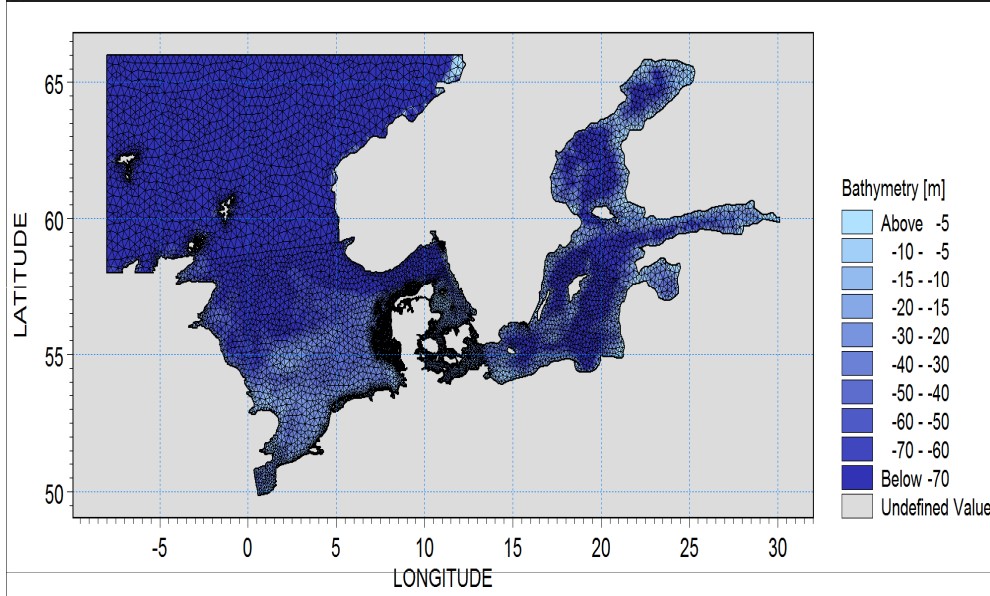

Depth adaptive flexible mesh models for hydrodynamics (tide+storm surge) and waves

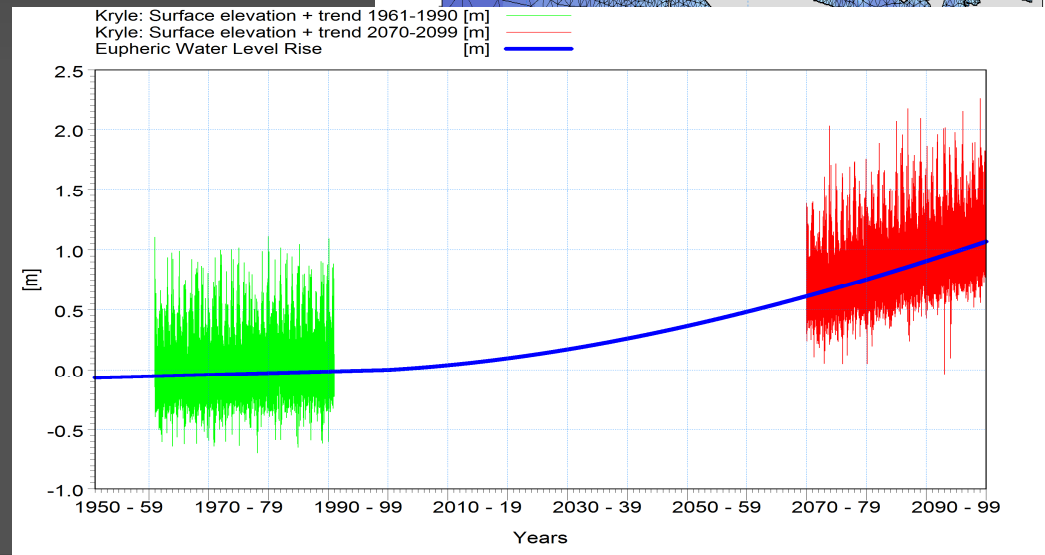

# Design wave conditions

Significant wave height (3-hourly) with a return period of 100 years

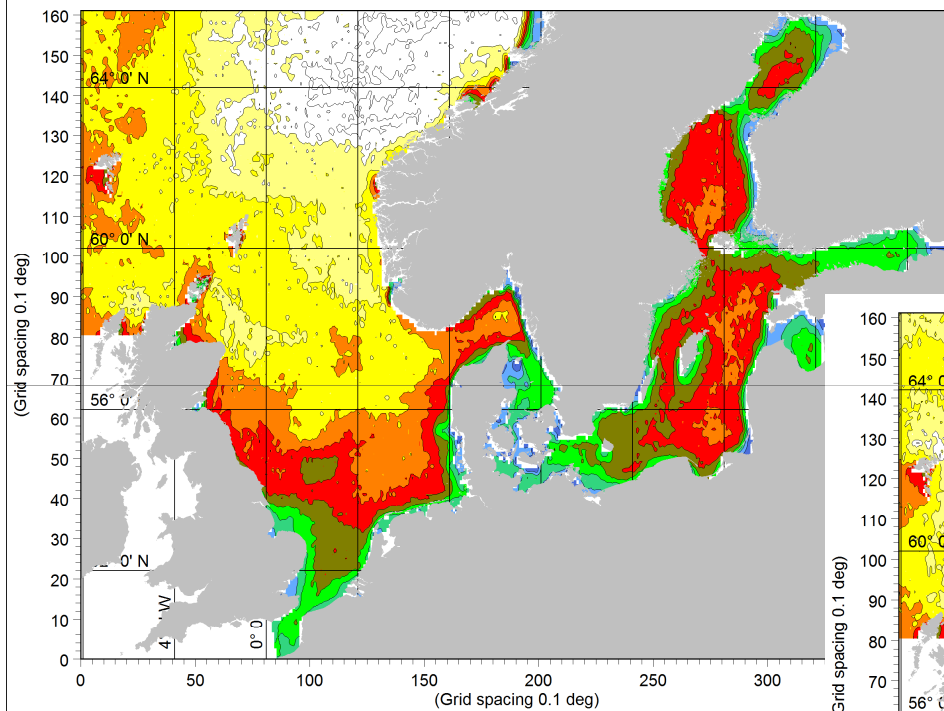

1961-1990

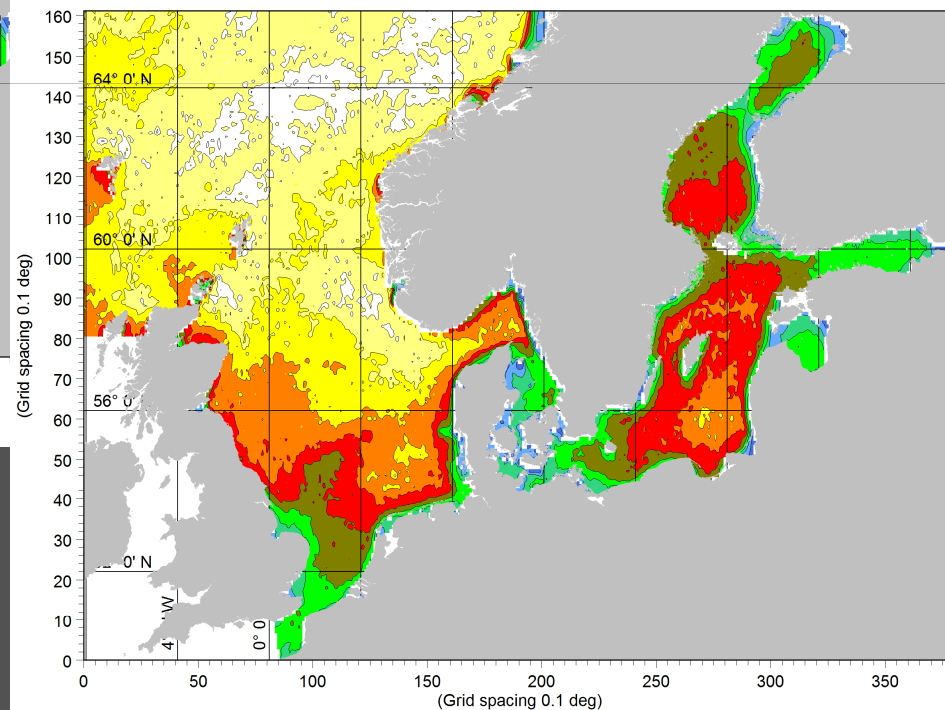

2071-2100

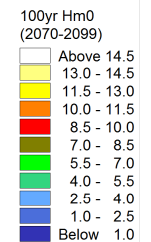

# Design wave conditions

Increase / decrease in significant wave height (3-hourly) with a return period of 100 years

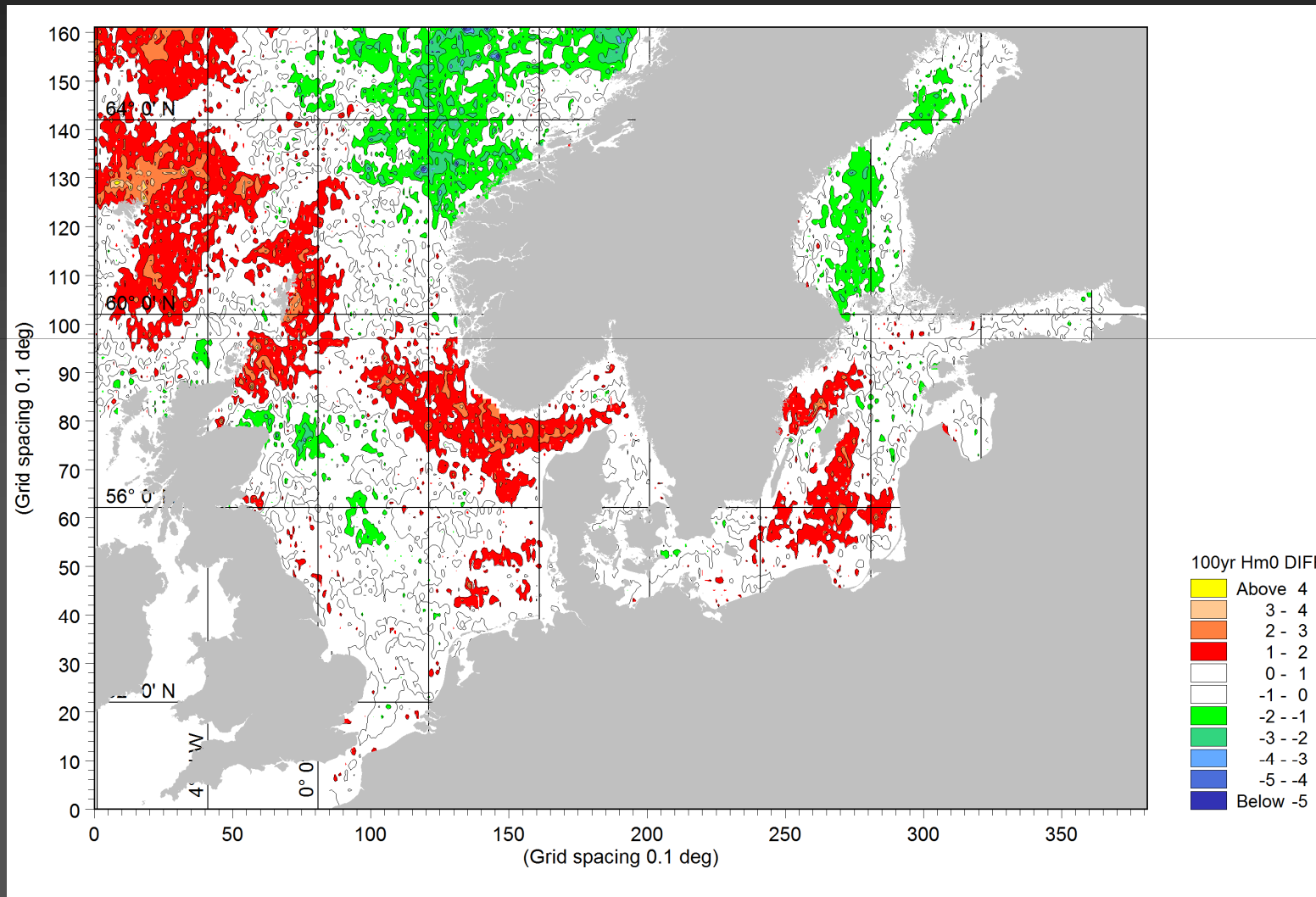

# Design water level conditions (surge)



Increase / decrease in water level (surge) excluding SLR with a return period of 100 years

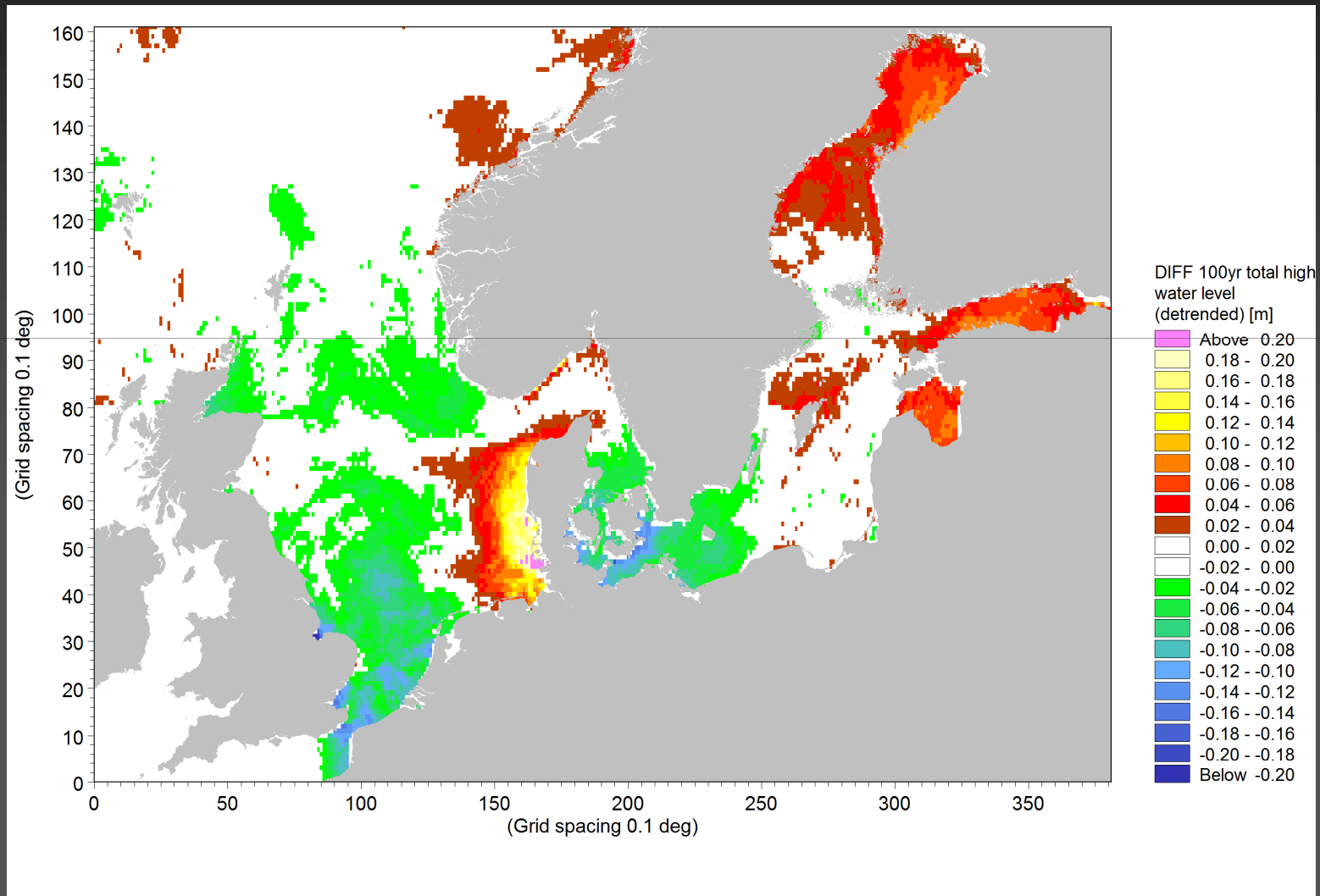

# Nearshore wave conditions



Three data sets:



**Measured  
(Buoy)  
1992-2007:**

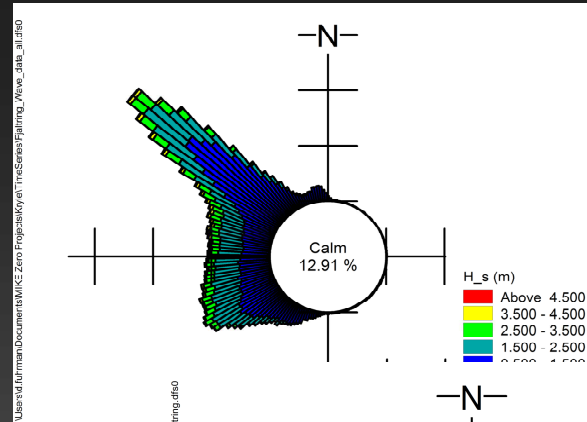

**Simulated  
(hindcast)  
1960-1990:**

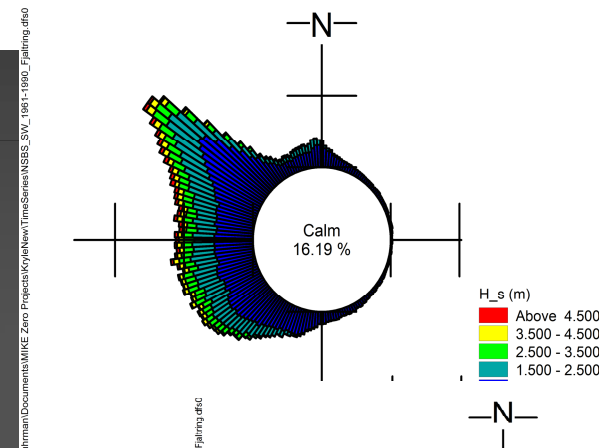

**Simulated  
(forecast)  
2070-2100:**

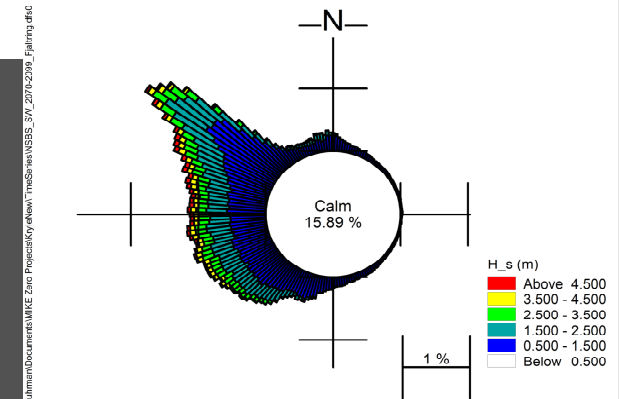

# Littoral drift



Simulated littoral drift at Hvide Sande (southward)

(based on down scaling)

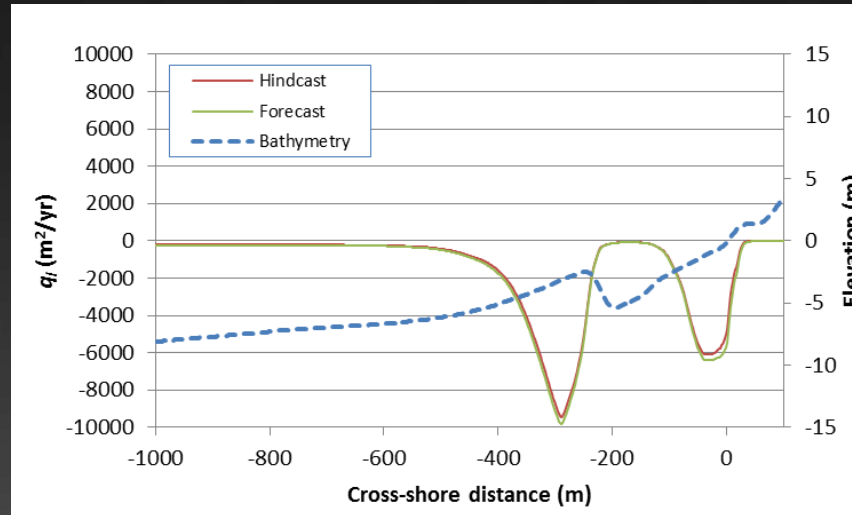

## Orientation

- Increase in littoral drift 10%
- Shift in equilibrium orientation

Uncertainty due to down scaling: +/- 4 deg 10-20%

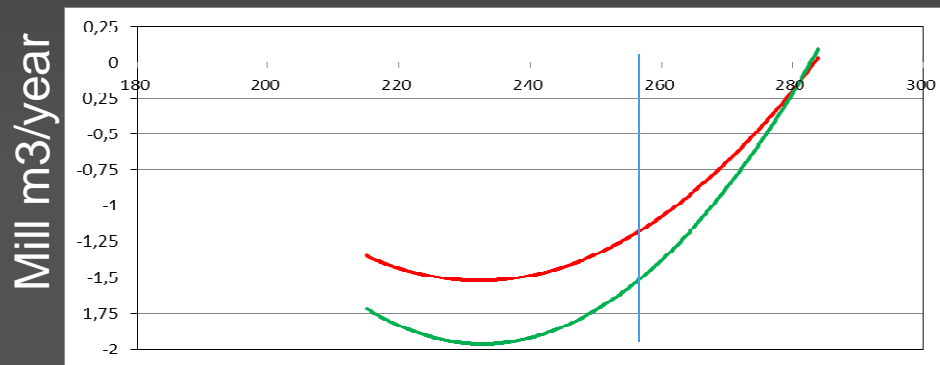

Hind cast  
Forecast

- Time scale for profile changes << change in mean sea level

# Nourishment at The Danish West Coast



Magnitude of existing erosion problem relative to erosion caused by SLR only:

Typical natural erosion rate: 3 m/year

SLR in year 2100: 0.5 m -1.0 m

Slope of beach: 1:100

Coastal erosion due to SLR:  $\Delta x = 50\text{m}-100\text{m} /90\text{yr}$

or 20-40% of present natural erosion.

The present yearly nourishment: approx 3 mill  $\text{m}^3$  – stabilises selected stretches



**The required nourishment will increase: 20-40 % from SLR, 10% from increased littoral drift**



# “Climate change adaptation as it affects the dredging community” draft CEDA position paper

Pol Hakstege

Chairman CEDA WG CCA

Dredging Days November 10 Rotterdam

[www.dredging.org](http://www.dredging.org)



World Organisation of Dredging Associations





# Objectives of CEDA position paper on climate change adaptation (draft)

- To raise awareness of the dredging community to be prepared for climate change;
- How can dredging contribute to adaptation measures?
- What are the implications for the dredging community?
- Focus is on anticipation on consequences of climate change not on causes.

# Adaptation measures

- Absolutely necessary to reduce the consequences of climate change by reducing vulnerability and/or improving resilience
- Integrated sustainable approach:
  - safety against flooding,
  - environmental protection and improvement,
  - economics, stakeholder and societal interests
- Short term: data collection and monitoring (understanding and risk assessment)
- Long term: realise adaptation measures (flexibility)

# Potential climate change implications for dredging community

- Changes in dredging volumes and/or locations
- Sustainable sediment management solutions
- **Flexibility is vital** (uncertainties, extreme events)
- Dredging methodologies (reactive or proactive)
- New and innovative solutions are required
- Specific equipment for new types of operations

# Effect of SRL on design water level

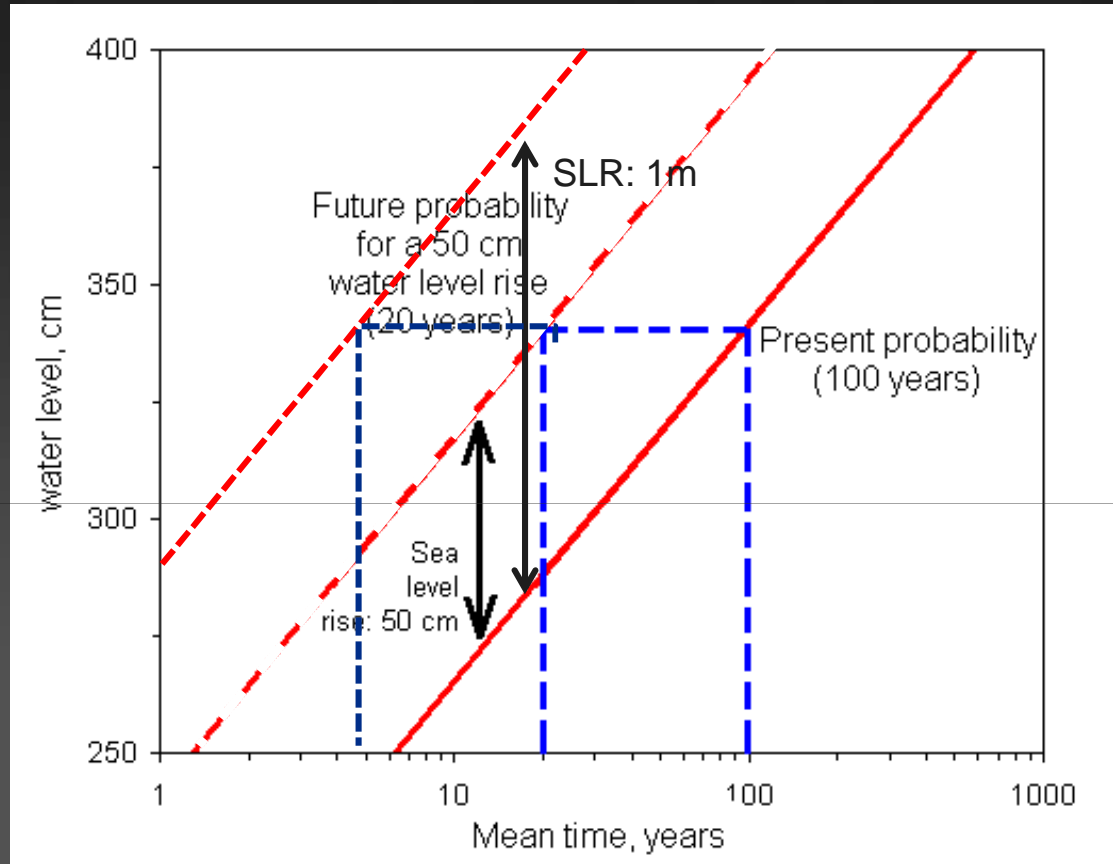

-with no changes in surge

**Red and blue:** Example from Denmark (100-year to 20-year event for 0.5 m)  
(100-year to 5-year event for 1.0 m)

# Examples



# Maintenance of Dutch coast line by beach nourishment

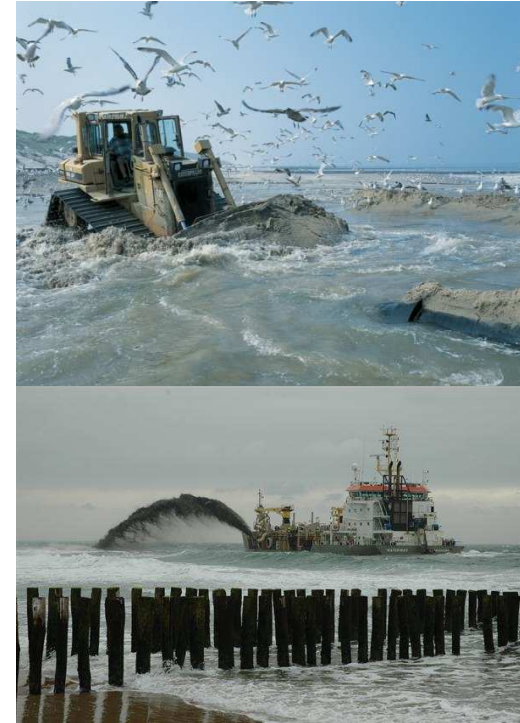

- At this moment: 12 million m<sup>3</sup>/yr
- Expectation for coming decades: 20 mill m<sup>3</sup>/yr, in the future 4 times more
- Increase in sand supply and sources further away
- Complexity: logistics, ecological and morphological response

# Working or Building with Nature

- Use dynamics of natural system as starting point for the design
- Example Sand Engine: mega nourishment Dutch Coast
- Combining safety with space for nature development and recreation, use natural processes for distribution of sand
- From defensive (minimize environmental impacts) to proactive approach (optimize full economic and environmental potential)

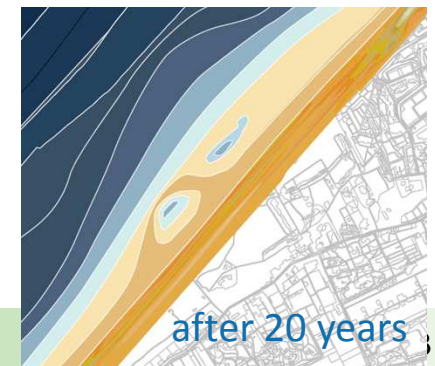

# Hvide Sande, Denmark

- Proactive dredging, innovative dredging scheme

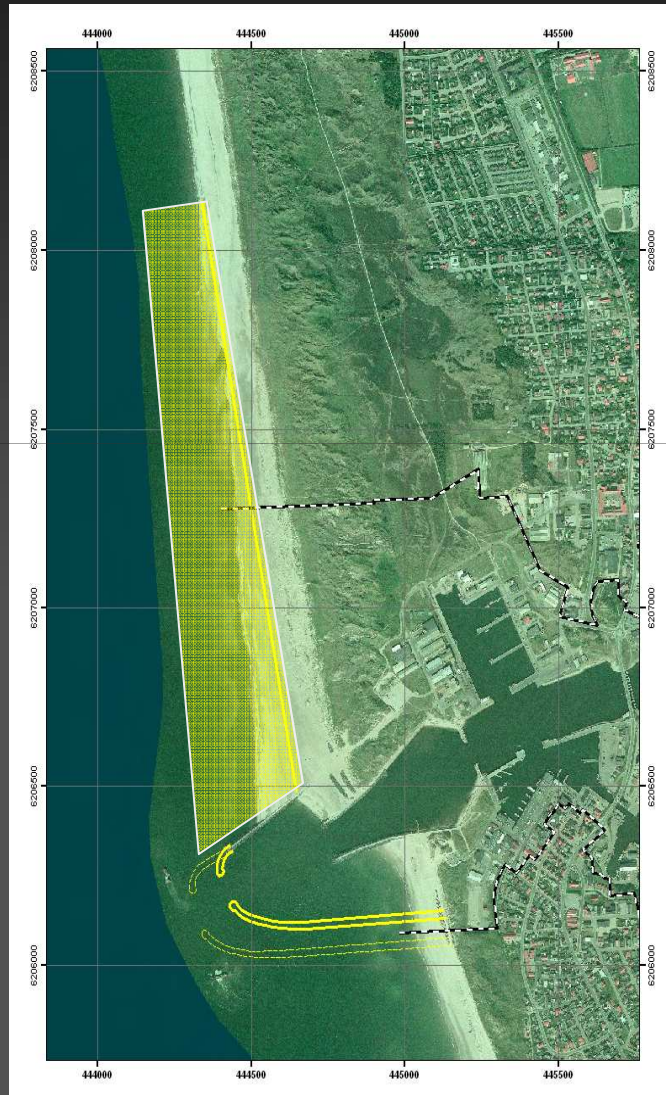

Future harbour:

Harbour wishes to increase navigation depth to 6.0 m *and* reduce sedimentation in the access channel

Main elements of the future harbour are:

- 70 m extension of existing breakwater
- new southern breakwater (~750 m)
- capital dredging of 1,200,000 m<sup>3</sup> over 1,600 m north of the harbour
- Maintenance of the "retreated" up-drift beach to optimize natural bypass



# Equilibrium bathymetry for future harbour

Model is run until new dynamic equilibrium is reached  
– obtained within 2 design periods/typical winter seasons

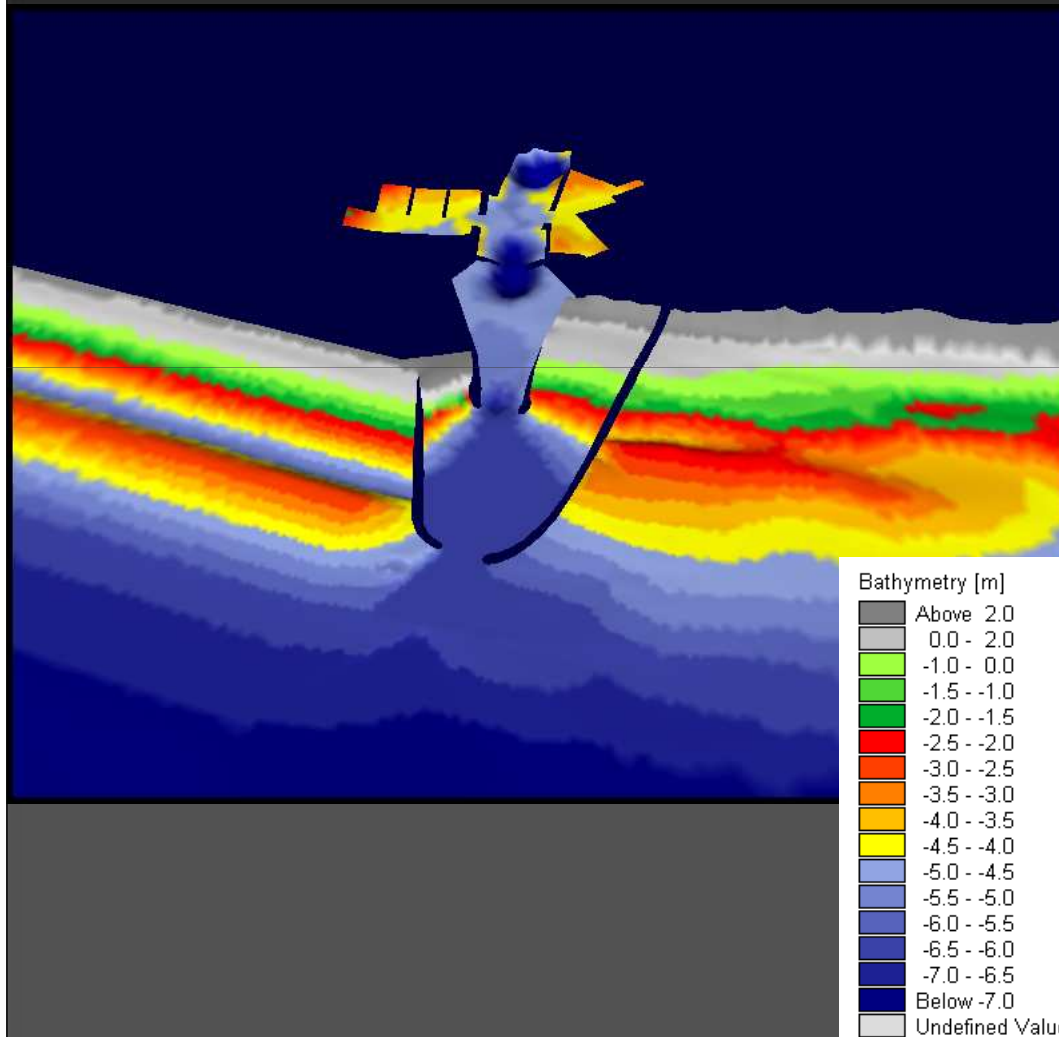

# Combined Scheme: Køge Bay Beach Park

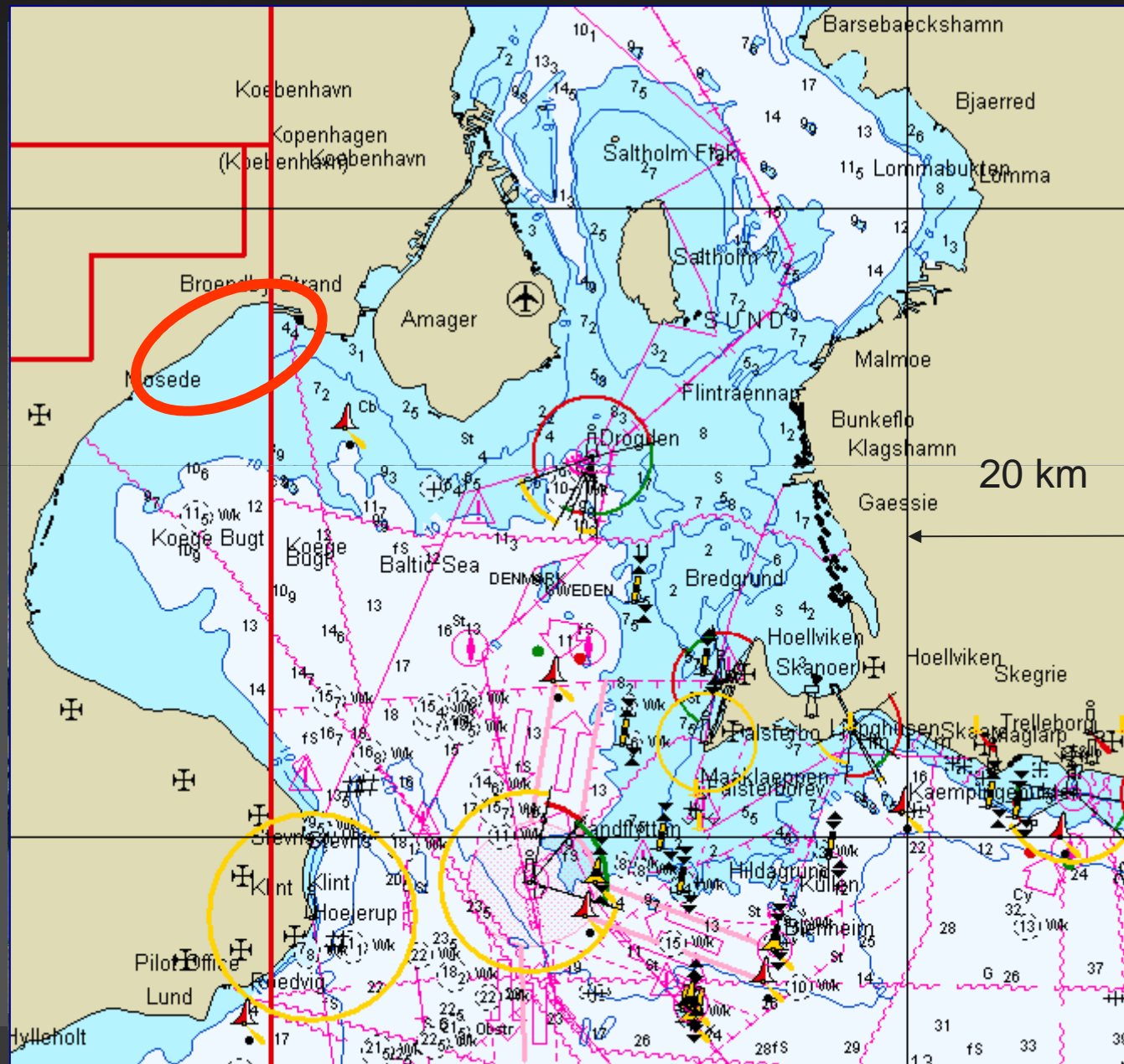

# Combined scheme

- Køge Bay Beach Park: Combining coastal and lagoon rehabilitation, marinas and sea defence



Completed in 1980  
Beach length: 7 km  
Sand fill. 5.0 mill m<sup>3</sup>  
4 marinas  
10 km dikes  
Lagoons/marinas: 2 mill m<sup>2</sup>

# Closing remarks

## Technicalities

- IPCC and the scientific community provide forecast for future global conditions
- Meteorological institutes scale climate scenarios to regional scale
- Regional scale results provide boundary conditions for local scale

## Challenges

- Uncertainty in forecast
- Which planning horizon to choose

## And note

Climate changes do not stop in year 2100

Innovative sustainable and integrated projects and management schemes shall be developed to service the needs of the society

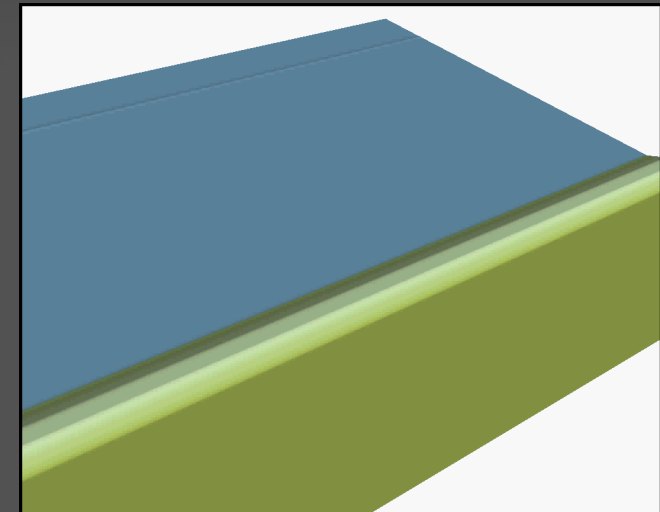

Extra



# Storm surges in the Limfjord



Investigation of morphological and climate effects on storm surge levels in the Limfjord system

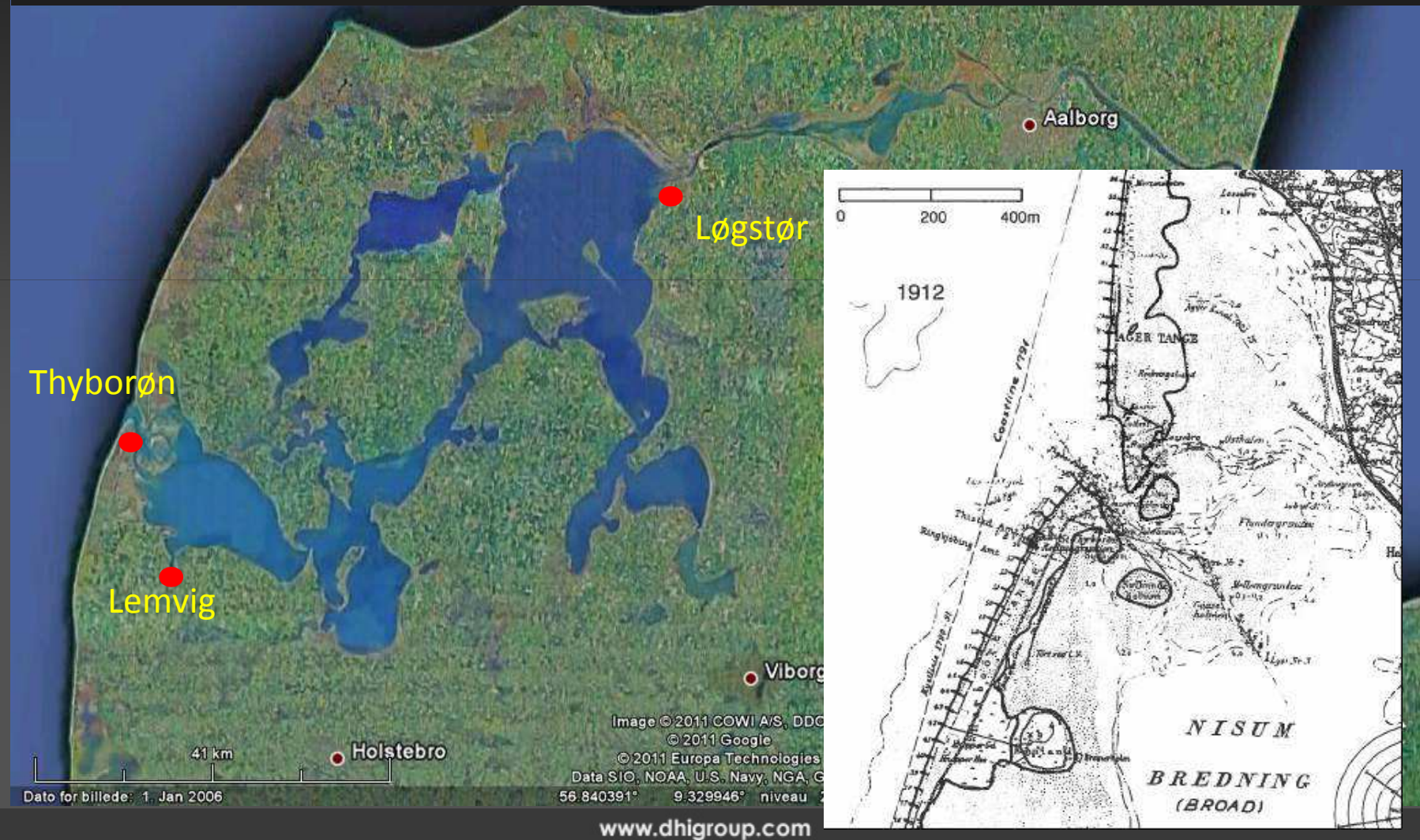

# On-going morphological development interact with CC

- Rise of mean sea level
- Increased wind speed
- Change in wind direction
- Increased surge levels in the North Sea

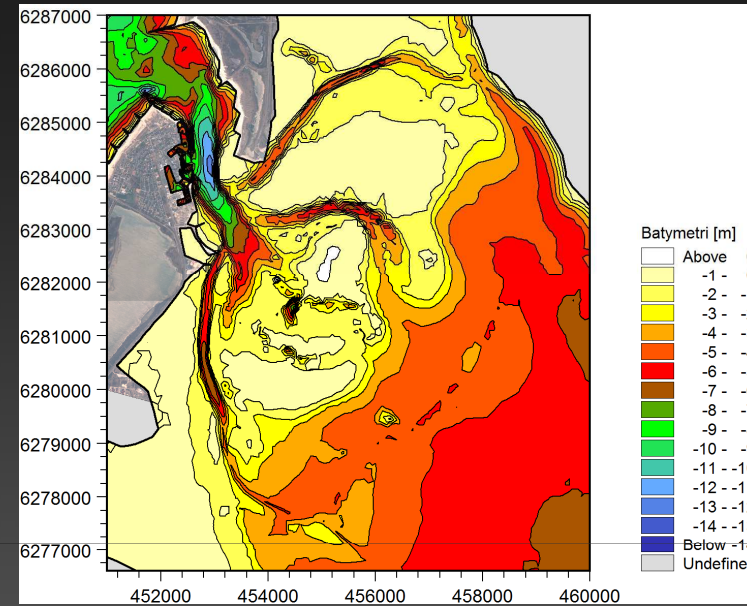

1958

bed level change from 1958 to 2005

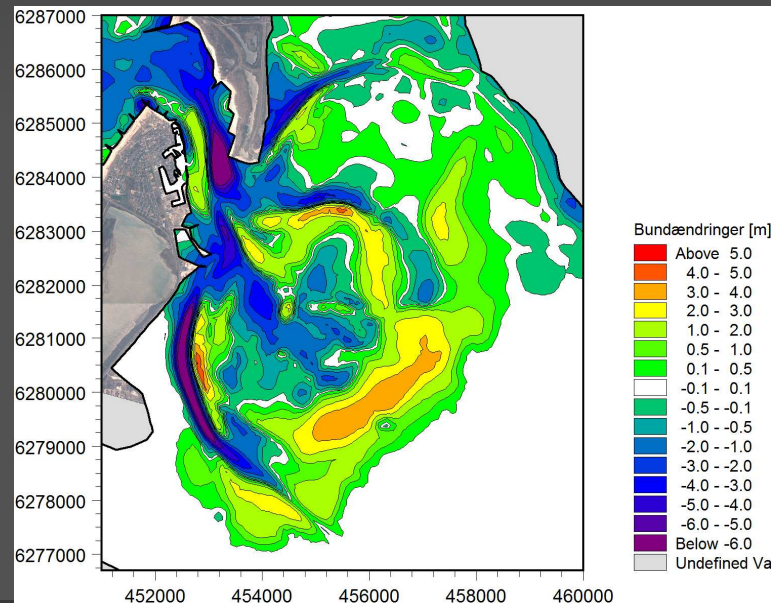

# Examples: Max surge level for two storms



Short storm, the North Sea surge level peaks at the same time as the wind

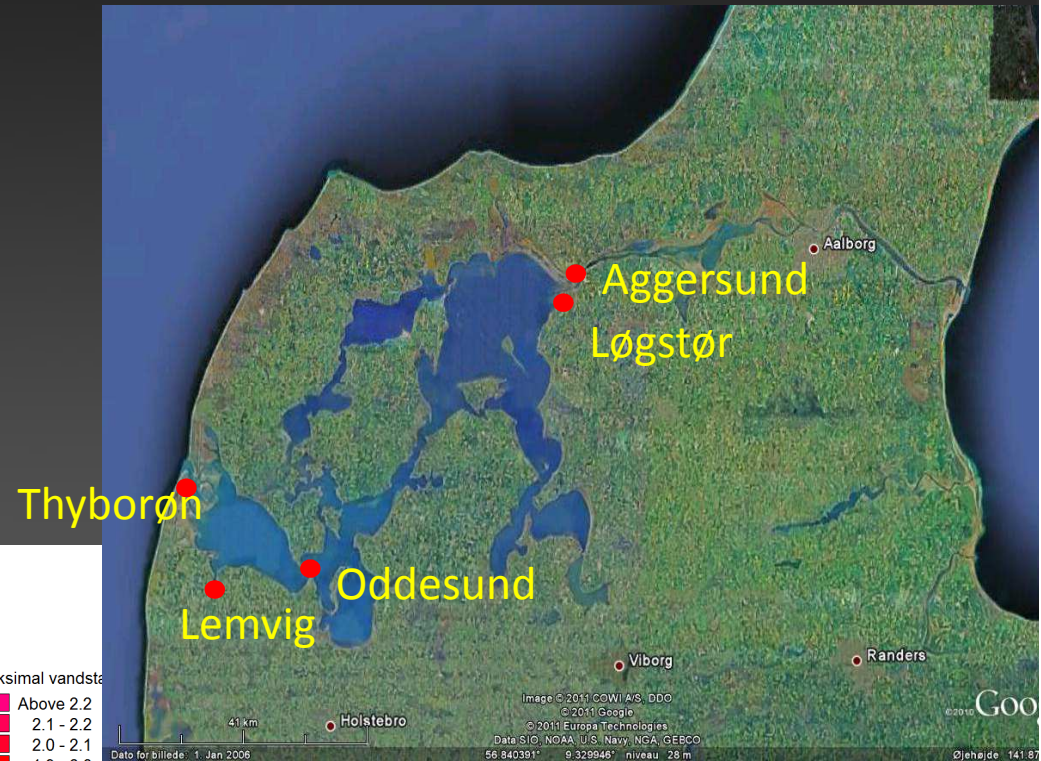
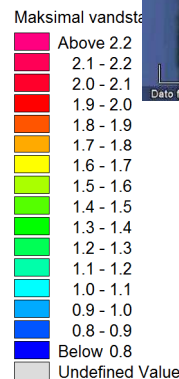
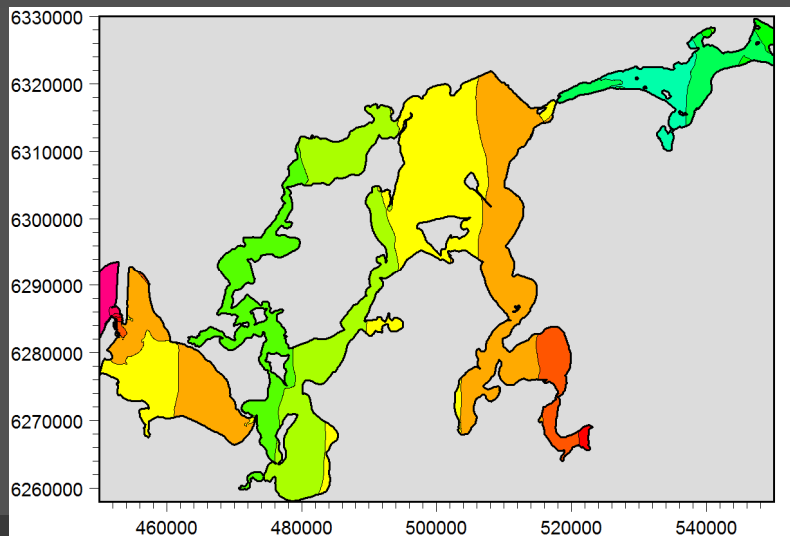
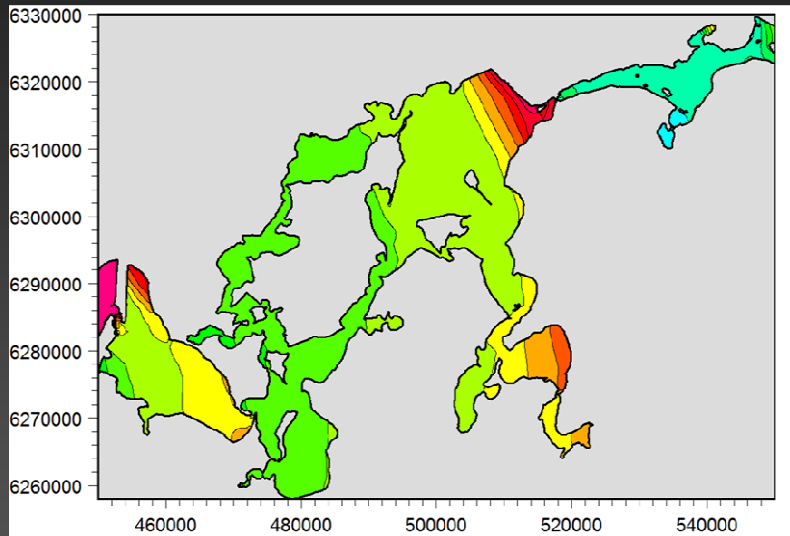

the North Sea surge level is maintained for a long time after the storm has peaked.



Historical storms (wind conditions and water level at the North Sea boundary) were simulated for 2005 and 2060 bathymetry.



The effect of increased cross-section at Thyborøn

Average for 6 storms:	Climate change sensitivity (two examples)		
	Surge +20%	Duration +30%	wind +10%
Thyborøn Harbour: <b>8 cm</b>	33/35 cm	1/5 cm	3/0 cm
Lemvig: <b>15 cm</b>	33/34 cm	5/8 cm	4/-1 cm
Løgstør: <b>5 cm</b>	16/25 cm	6/17cm	32/10 cm
East of Aggersund: <b>&lt;3 cm</b>			

CCA design shall include:

- SRL
- +
- Effects of morphological change
- Storm surge
- Storm duration
- Local wind set-up

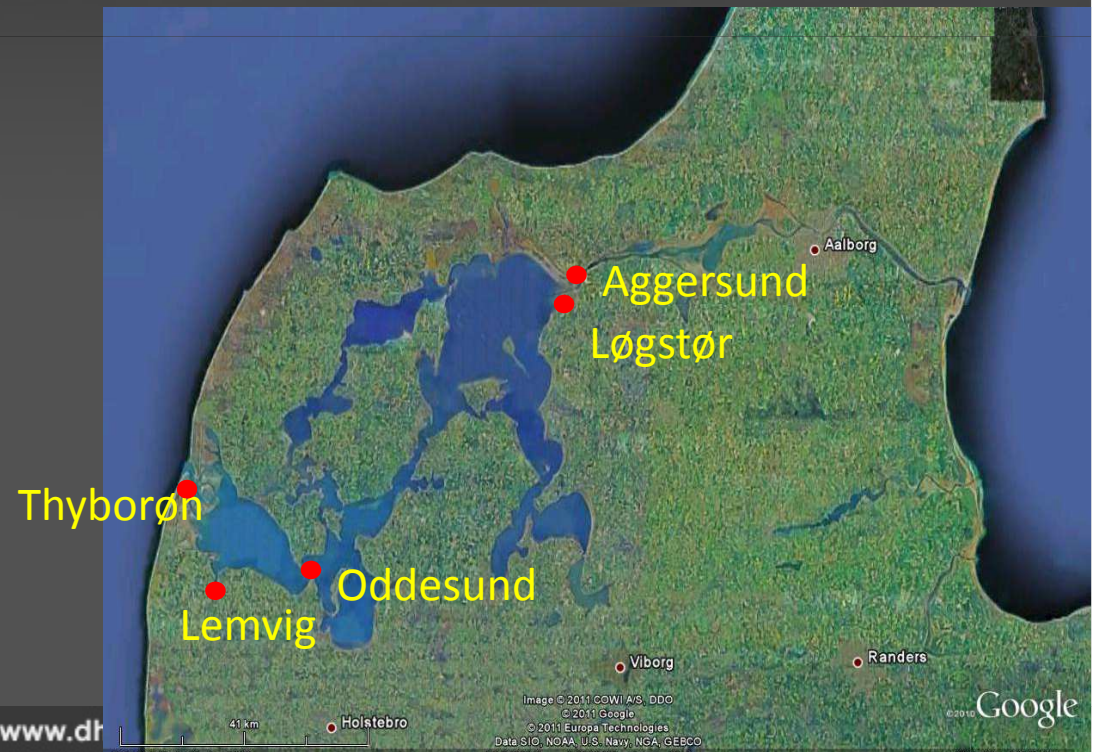

# Soft protection against overtopping

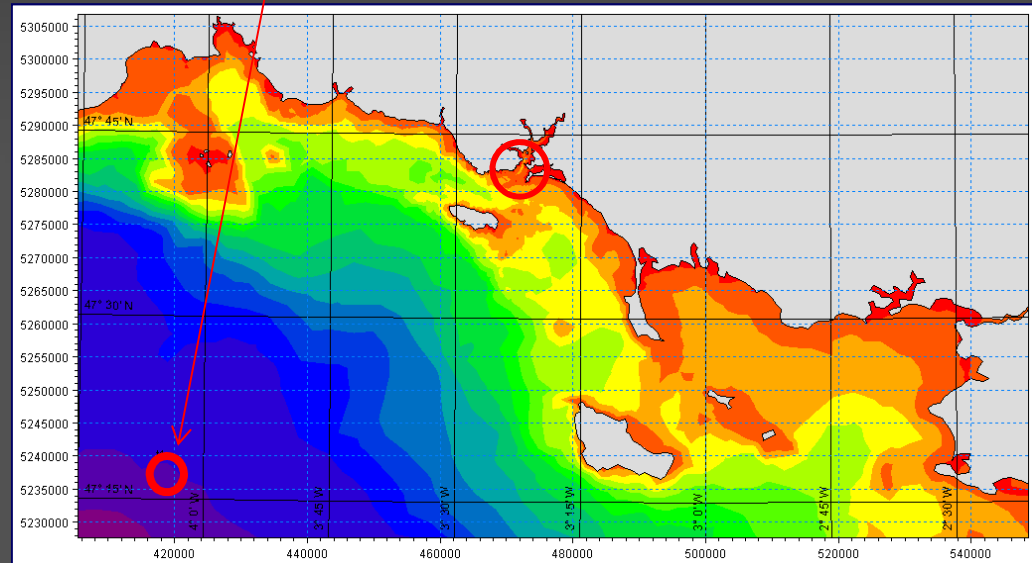
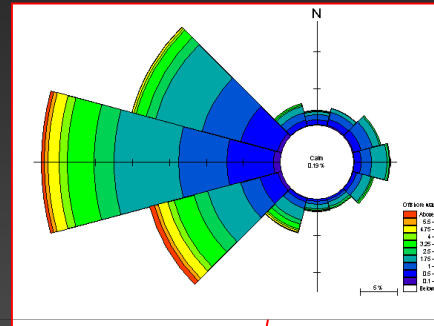
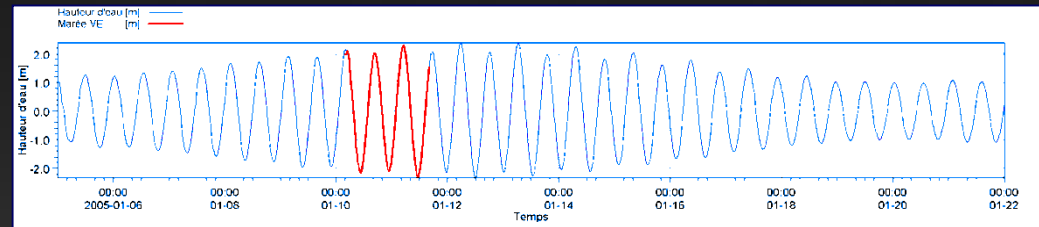
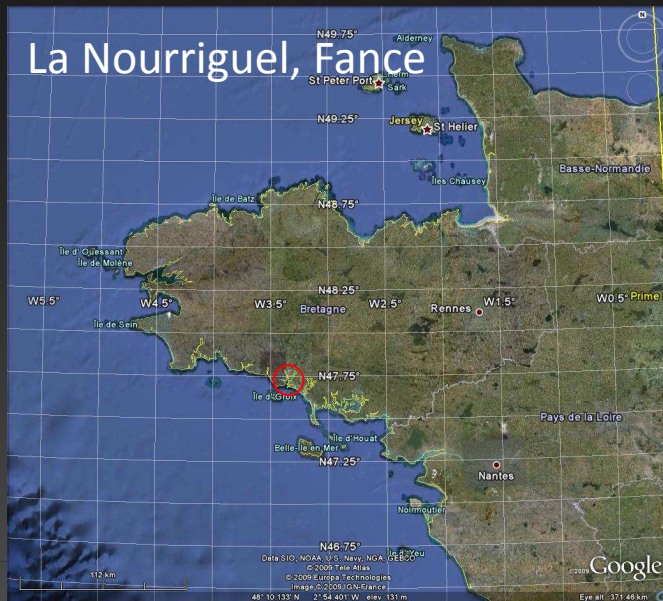

# Present conditions



Bad weather ..

# Regional and local waves

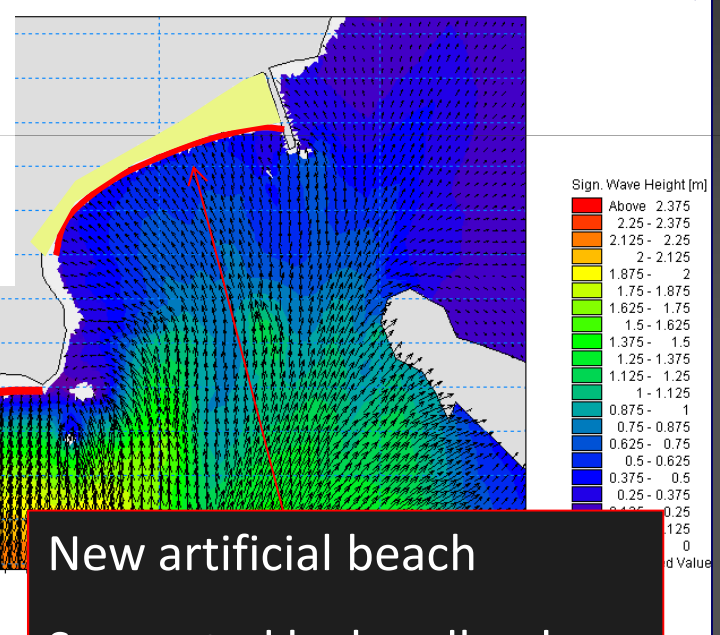
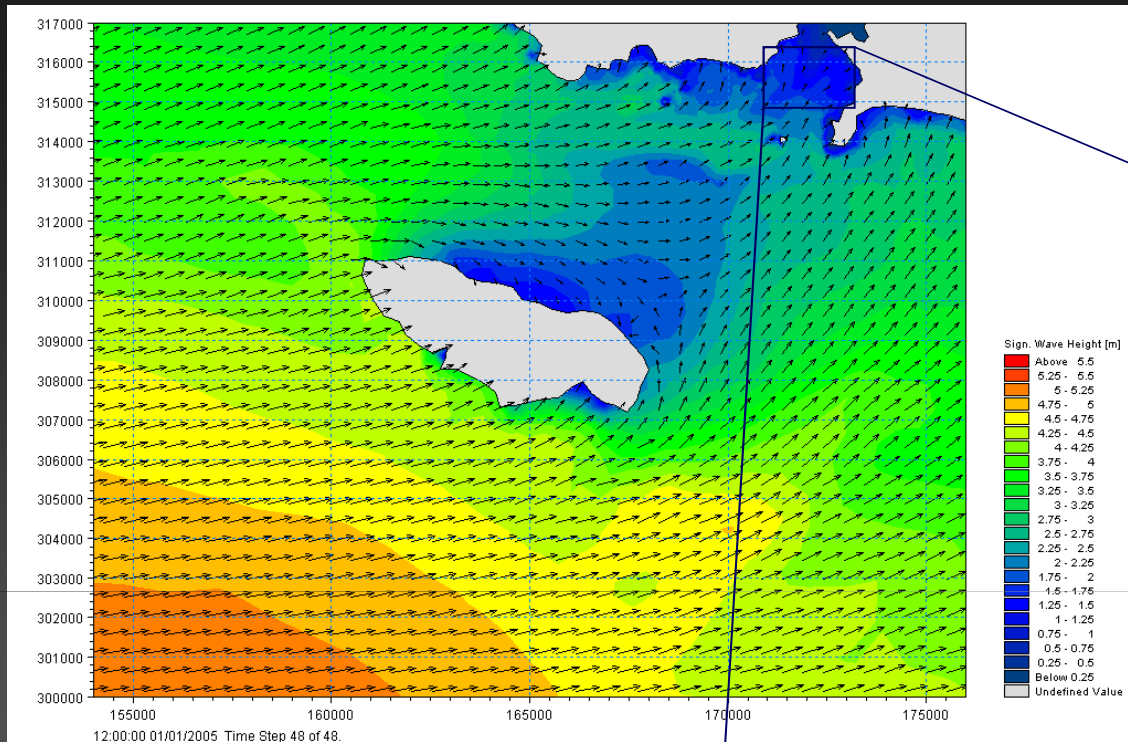

Natural stable beach aligned to face the dominant waves

New artificial beach  
Supported by headland  
Aligned to dominant wave direction



After ...



Wave, current and sediment transport modelling has supported the design of the future stable sandy beach and headland

Sandy beach will dissipate wave energy before waves hit the wall

Designed also for SLR